

### Silicon Planar PIN Photodiode

### PD70-01C/TR10

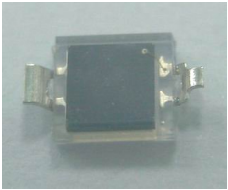

#### Features

- High sensitivity
- Low capacitance
- Short switching time
- Wide temperature range
- Small package
- Pb free
- The product itself will remain within RoHS compliant version.

#### Descriptions

- The PD70-01C/TR10 is high sensitivity, fast switching times, low capacitance, compact size, and lack of measurable degradation make it suitable for diverse applications, such as TV and appliance remote control, IR sound transmission, video recorders, and measurement and control.

#### Applications

- High speed photo detector
- Copier
- Elevator

#### Device Selection Guide

Part Category	Chip Material	Lens Color
PD	Silicon	Water clear

Package Dimensions

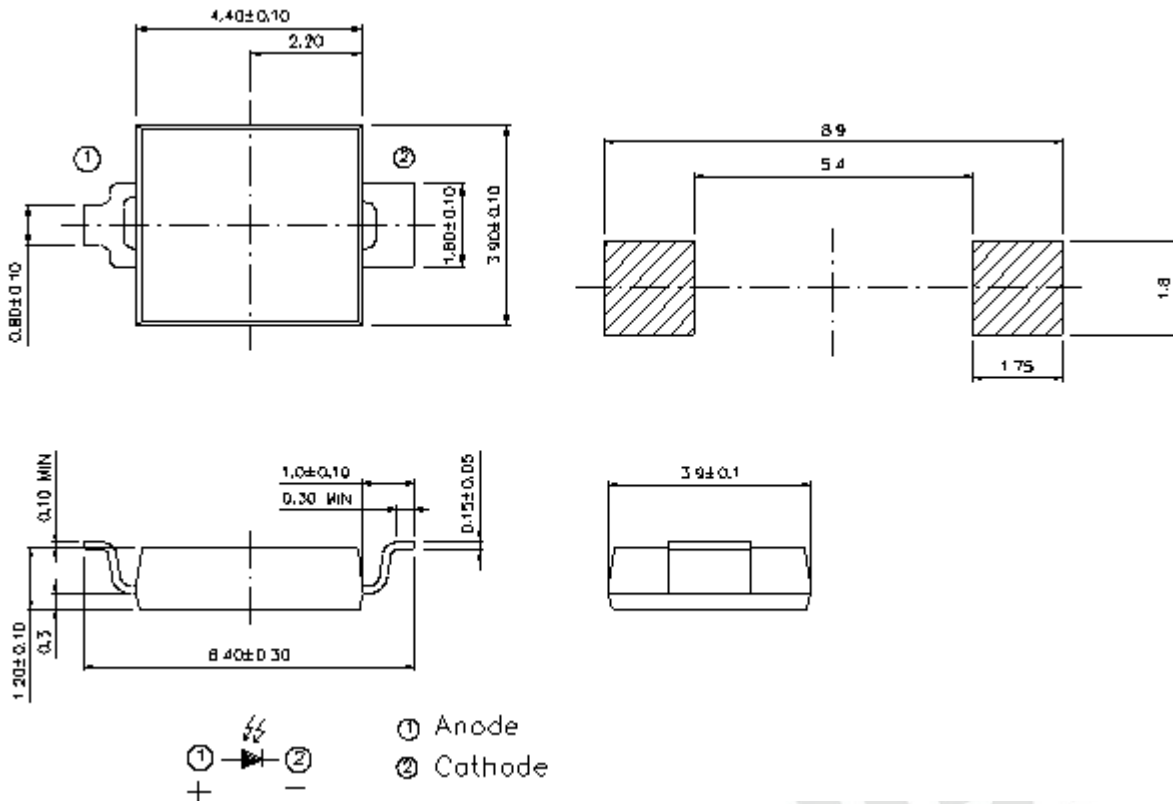

**Notes:** 1.All dimensions are in millimeters  
2.Tolerances unless dimensions  $\pm 0.1\text{mm}$

### Absolute Maximum Ratings (Ta=25 )

Parameter	Symbol	Rating	Units
Reverse Voltage	$V_R$	32	V
Operating Temperature	$T_{opr}$	-25 ~ +85	
Storage Temperature	$T_{stg}$	-40 ~ +85	
Soldering Temperature *1	$T_{sol}$	260	
Power Dissipation at (or below) 25 Free Air Temperature	$P_d$	150	mW

Notes: \*1: Soldering time 5 seconds.

### Electro-Optical Characteristics (Ta=25 )

Parameter	Symbol	Condition	Min.	Typ.	Max.	Units
Rang of Spectral Bandwidth	$\lambda_{0.5}$	---	400	---	1100	nm
Wavelength of Peak Sensitivity	$\lambda_p$	---	---	940	---	nm
Short- Circuit Current	$I_{sc}$	Ee=1mW/cm <sup>2</sup> $\lambda_p=875nm$	---	35	---	$\mu A$
Reverse Light Current	$I_L$	Ee=1mW/cm <sup>2</sup> $\lambda_p=875nm$ $V_R=5V$	17	25	---	$\mu A$
Reverse Dark Current	$I_D$	Ee=0mW/cm <sup>2</sup> $V_R=10V$	---	5	30	nA
Reverse Breakdown Voltage	$V_{BR}$	Ee=0mW/cm <sup>2</sup> $I_R=100\mu A$	32	170	---	V

### Typical Electro-Optical Characteristics Curves

Fig.1 Spectral Sensitivity

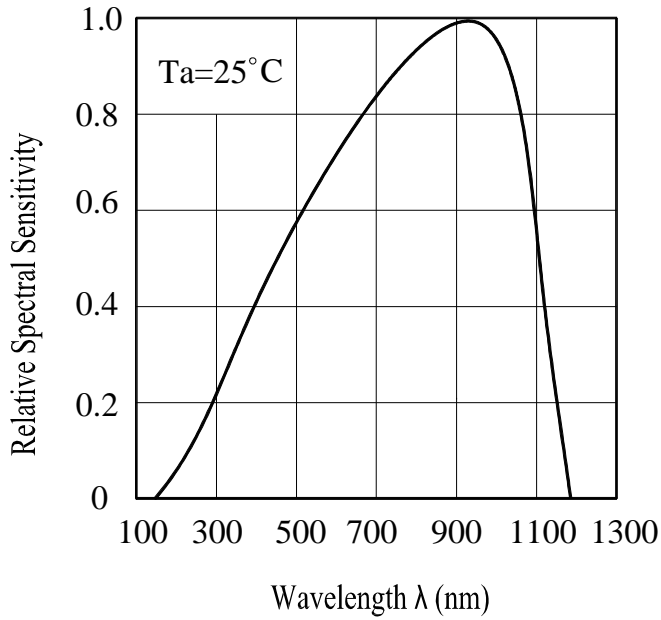
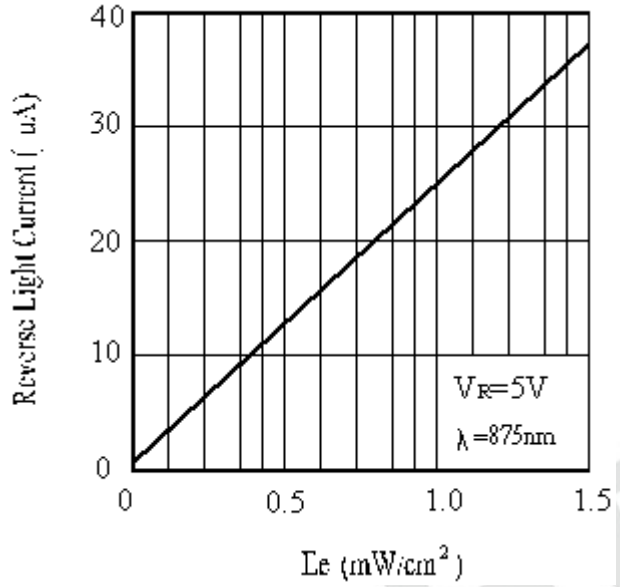

Fig. 2 Reverse Light Current vs.  $E_e$



## Precautions For Use

### 1. Over-current-proof

Customer must apply resistors for protection, otherwise slight voltage shift will cause big current change ( Burn out will happen ).

### 2. Storage

2.1 Do not open moisture proof bag before the products are ready to use.

2.2 Before opening the package, the Photodiode should be kept at 10 ~30 and 90%RH or less.

2.3 The Photodiode suggested be used within one year.

2.4 After opening the package, the devices must be stored at 10°C~30°C and  $\leq 60\%RH$ , and used within 168 hours (floor life). If unused Photodiode remain, it should be stored in moisture proof packages.

2.5 If the moisture absorbent material (desiccant material) has faded or unopened bag has exceeded the shelf life or devices (out of bag) have exceeded the floor life, baking treatment is required.

2.6 If baking is required, refer to IPC/JEDEC J-STD-033 for bake procedure or recommend the following conditions:

96 hours at 60°C  $\pm$  5°C and < 5 % RH (reeled/tubed/loose units)

### 3. Soldering Condition

#### 3.1 Pb-free solder temperature profile

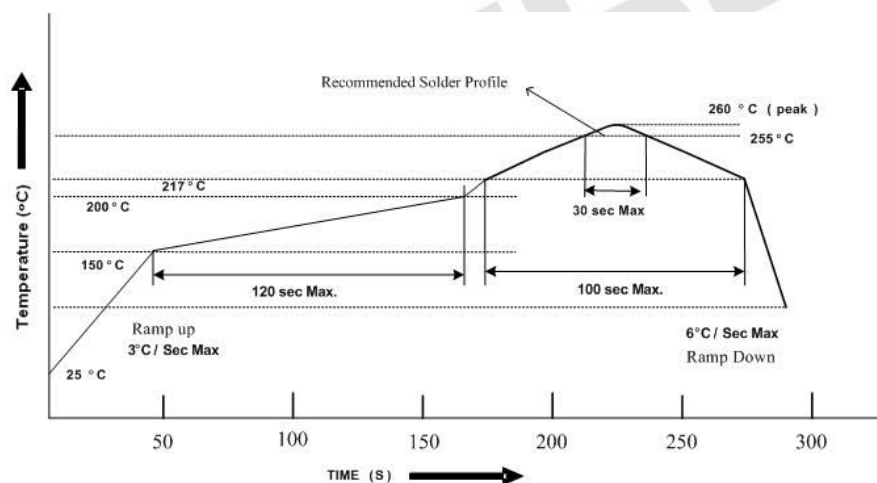

3.2 Reflow soldering should not be done more than two times.

3.3 When soldering, do not put stress on the Photodiode during heating.

3.4 After soldering, do not warp the circuit board.

#### 4. Soldering Iron

Each terminal is to go to the tip of soldering iron temperature less than 350 for 3 seconds within once in less than the soldering iron capacity 25W. Leave two seconds and more intervals, and do soldering of each terminal. Be careful because the damage of the product is often started at the time of the hand solder.

#### 5. Repairing

Repair should not be done after the Photodiode have been soldered. When repairing is unavoidable, a double-head soldering iron should be used (as below figure). It should be confirmed beforehand whether the characteristics of the Photodiode will or will not be damaged by repairing.

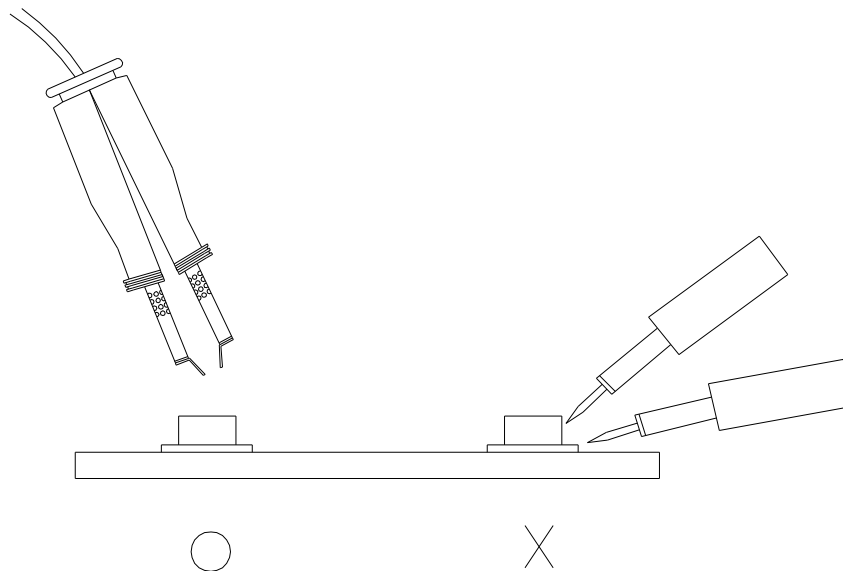

Package Dimensions

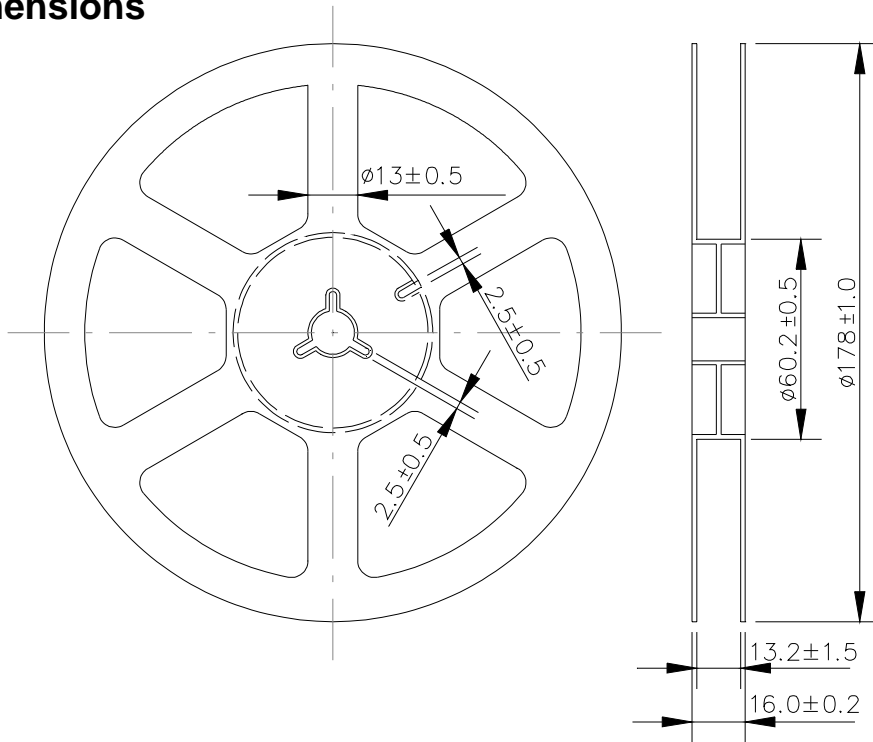

Note: The tolerances unless mentioned are  $\pm 0.1$  mm, unit: mm.

Carrier Tape Dimensions: (Quantity: 1000PCS/Reel)

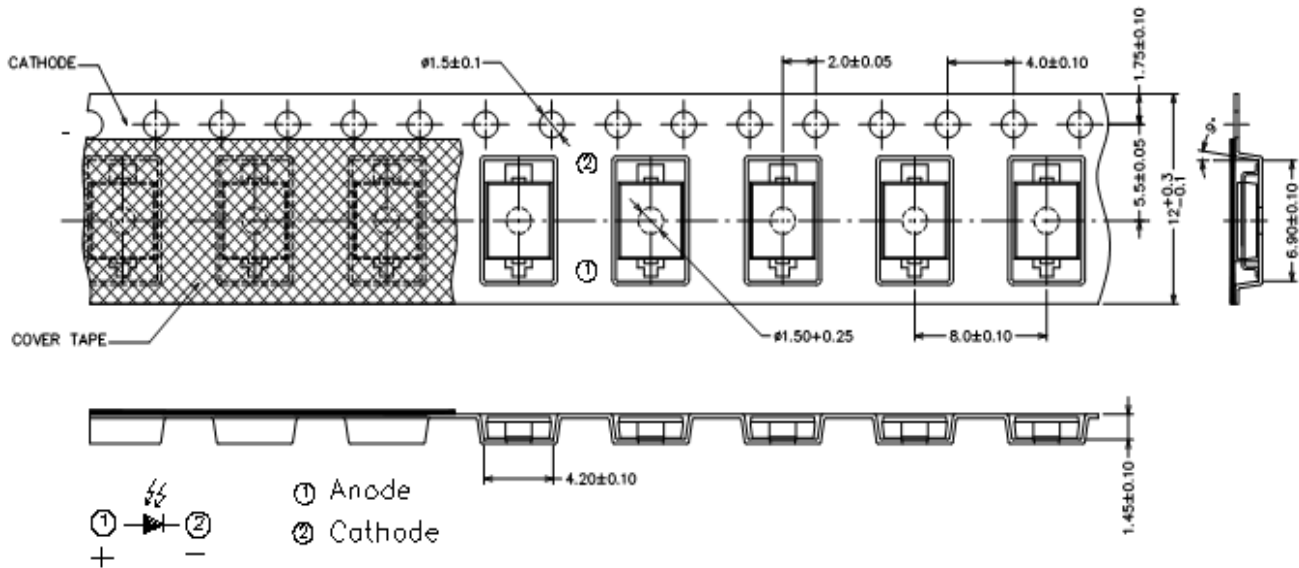

Note: The tolerances unless mentioned are  $\pm 0.1$  mm, unit: mm.

### Label Form Specification



CPN: Customer's Production Number  
P/N : Production Number  
QTY: Packing Quantity  
CAT: Ranks  
HUE: Peak Wavelength  
REF: Reference  
LOT No: Lot Number

### Notes

1. Above specification may be changed without notice. EVERLIGHT will reserve authority on material change for above specification.
2. The graphs shown in this datasheet are representing typical data only and do not show guaranteed values.
3. When using this product, please observe the absolute maximum ratings and the instructions for use outlined in these specification sheets. EVERLIGHT assumes no responsibility for any damage resulting from use of the product which does not comply with the absolute maximum ratings and the instructions included in these specification sheets.
4. These specification sheets include materials protected under copyright of EVERLIGHT. Reproduction in any form is prohibited without the specific consent of EVERLIGHT.
5. This product is not intended to be used for military, aircraft, automotive, medical, life sustaining or life saving applications or any other application which can result in human injury or death. Please contact authorized Everlight sales agent for special application request.

**EVERLIGHT ELECTRONICS CO., LTD.**  
Office: No. 6-8, Zhonghua Rd., Shulin Dist.,  
New Taipei City 23860, Taiwan

Tel: 886-2-2685-6688  
Fax: 886-2685-2699 , 6897  
<http://www.everlight.com>